

Experimental Analysis of Fracture and Damage Mechanics of Pre-Stressed Concrete Sleepers B70: Part B- Analysis

Seyed .Mohammad Farnam¹, Fereydoon Rezaie²

Received: 11. 07. 2016 Accepted: 31. 10. 2016

Abstract

Initial cracks occur in high strength concrete sleepers for various reasons, such as shrinkage and wrong curing and long lifetime of over 50 years of sleepers. These cracks may lead to complete failure of the structure. In order to more accurately design the sleepers, fracture mechanics (not strength of materials) should be incorporated. In order to achieve this purpose, it is important to forecast crack growth and residual strength reduction rate. In this study, based on the principles of nonlinear fracture mechanics (NLFM) in concrete material, fracture behavior of pre-stressed concrete sleepers was investigated. Sleepers with the lengths of initiation crack of 5 mm with 10 mm step increasing to 45 mm were tested. Five specimens in each group were loaded under three-point bending test, in order to calculate K_{Ic} , crack growth, and load-displacement diagram. The results showed that by increasing the crack-to-depth ratio, initial toughness, crack stability, and crack unstable toughness, the crack instability expansion begins. By increasing the crack-to-depth ratio, both initial and unstable toughness values increased linearly versus LEFM theory. Damage begins with an initial crack like in flexural damage and then continues with bifurcation of the crack. The influence of shear damage in sleeper's crack growing leads it to the ultimate damage.

Keywords: Fracture mechanics, damage mechanics, pre-stressed concrete sleeper b70, stress intensity factor, crack-to-depth ratios.

1. Introduction

Railway transportation is among the most popular modes of transportation in the world

Corresponding author E-mail: frrezaie94@gmail.com

¹ Ph.D Candidate, Department of Civil Engineering, Bu-Ali Sina University, Hamedan, Iran

² Associate Professor, Department of Civil Engineering, Bu-Ali Sina University, Hamedan, Iran

and therefore maintaining its safety seems to be of great importance. To achieve this goal, various issues, including possible modes of different components of the railway lines should be analyzed. Sleepers are one of the main railroad components, receiving the force from the wheels and conveying it to the rails. The force is then transferred to the ballast layer, while a constant spacing between the lines is maintained [Zhao, Chan and Burrow, 2007]. Sleepers are constructed from different materials, such as timber, steel, and concrete [Thai and Kim, 2014]. Timber sleepers were used in the past, but nowadays, their usage has been limited due to the high prices and scarcity of wood. On the other hand, concrete elements could not be eaten by insects and fungi, so they have a good resistance to environmental conditions. Therefore, the use of concrete sleepers has increased rapidly. Moreover, concrete sleepers are very low in price as compared to the timber sleepers. However, with the development of railway lines and abundance of heavy wagons and high-speed trains, these elements have proven to be inefficient. Therefore, sleepers with high-strength concrete and rebar are used to achieve high resistance. Since mono-block B70 pre-stressed concrete sleepers have high strength, more durable, and are also lighter than other sleepers, their usage is more common in I. R. Iran railway system.

Remennikov and Kaewuruen investigated the static behavior of pre-stressed concrete sleepers with an experimental method in view of non-linear properties of the materials [Remennikov and Kaewuruen, 2006]. They also compared the numerical and experimental response of the pre-stressed concrete sleepers under static and impact of loads with low velocity [Remennikov and Kaewuruen, 2007; Kaewuruen and Remennikov, 2007]. Rezaie and co- authors

studied longitudinal crack propagation in pre-stressed concrete sleepers. In their experimental and numerical studies, the effects of extra pressure in rawlplug positions were modeled by applying cylindrical pressure inside the holes [Rezaie, Shiri and Farnam, 2012]. Fracture and damage mechanics of pre-stressed concrete sleepers B70 were analyzed experimentally. González-Nicieza and co-authors investigated the failure analysis of a railway track used for transporting heavy haul industrial freight [González-Nicieza et al, 2008]. Three dimensional finite element methods and a series of experimental programs are used to examine the failure mechanism of concrete railway sleepers by Goangseup Zi and colleagues [Goangseup Zi et al. 2012]. Also, in 2014, fatigue and failure of Pre-stressed concrete sleepers (or railroad ties) were investigated using full-scale experimental tests [Remennikov and Kaewuruen, 2014].

From a fracture mechanics point of view, concrete behavior is quasi-brittle. Therefore, linear elastic fracture mechanics (LEFM) theory can be probably used to describe crack growth, fracture toughness, and other fracture mechanics parameters of concrete. The use of LEFM for concrete was documented by Kaplan [Kaplan, 1961]; however, it has been shown by a number of researchers, including Shah and Mac-Garry [Shah and Mac-Garry, 1971] that it is not an appropriate choice. In order to determine fracture mechanics model of concrete, a large number of experimental and numerical studies have been carried out. Several research works investigate the fracture properties of concrete elements in different conditions for specimens of different sizes. [Vesely, Konecny and Lehner, 2015; Eftekhari, Ardakani and Mohammadi, 2014; Santosh and Ghosh, 2015]. Azad and co-

authors investigated an experimental test which was performed on a series of simply supported concrete beams in order to determine the fracture energy of the composite beam and predict the flexural strength by applying the fracture mechanics concept [Azad, Mirza and Chan, 2007]. Ruiz et al. studied the fracture in lightly reinforced concrete beams using a method which showed that there is a direct relationship between load capacities and rebar ratio in the beam cross section [Ruiz, Elices and Planas, 1998]. Evaluation of the minimum reinforcement in the bridged crack model of concrete members has been examined experimentally and theoretically by Ferro and co-authors [Ferro, Carpinteri and Ventura, 2007]. In 2011, Shaowei and colleagues used an acoustic emission practice to find the parameters of normal concrete fracture properties [Shaowei, Jun and Xiaoqing, 2011]. Zhao and co authors investigated experimentally the uniaxial tensile creep behavior of pre-cracked steel fiber reinforced concrete. Cylindrical specimens were pre-cracked at crack opening displacement (COD) for damage evolution [Zhao, Prisco, and Vandewalle, 2015]. In recent years, studies have been conducted analyzing fracture mechanics of reinforced concrete; however, very few of these studies have addressed pre-stressed concrete, especially, using experimental and numerical methods [Rezaie, Shiri and Farnam, 2012]. Therefore, in this paper, the emphasis is placed on the experimental analysis of fracture and damage mechanics of pre-stressed concrete sleepers B70. The main fracture parameters of a notched pre-stressed concrete sleeper, such as the force-displacement diagram, crack growth, and K_{Ic} are calculated with NLFM theory. This research consists of two parts, Part A and B. In Part A, the experimental test is explained.

Replica test and image analysis are discussed to calculate crack parameters like: crack length, CMOD etc. In Part B, the results of experimental tests such as force-displacement and K_{Ic} and their effects on analysis and design of pre-stressed concrete sleepers are discussed.

2. Test Overview

2.1 Test Specimen

In this paper, center negative three-pointed bending is applied to notched pre-stressed concrete sleepers B70. In the majority of railway codes, 3-point-bending is used for the test. In fact, behaviors like a beam of pre-stressed concrete sleepers are tested in 3-point-bending. This method is also used for other structures [Malvar and Warren, 1987; Karihaloo and Nallathambi, 1989]. Loading conditions are based on negative center load test in "AREMA Chapter 30", "Australian Standard, AS 1085-14". In Figure 1, the actual geometrical sizes of pre-stressed concrete sleepers are shown. Characteristic of the mix design are shown in Table 1 for 1 m³ concrete. D_{Max} is the maximum size of aggregate in the mix design.

Five different initial crack lengths, namely 5, 15, 25, 35, and 45 mm are created according to the previously shown crack height and after the cutting shown in Figure 2a and b, respectively. Five specimens are made in each group. Specimens' initial crack widths are created as 8 mm with a portal crane with a negligible thickness relative to that of the specimen width.

Longitudinal rebar used for making the pre-stressed concrete sleepers B70 is ST-160 with 7 mm diameter. The mechanical characteristics of steel rebar are shown in Table 2.

Table 1. Characteristics of the mix design of concrete.

D_{Max}	Water	Cement	Gravel	Sand
25 mm	60 Kg	170 Kg	400 Kg	300 Kg

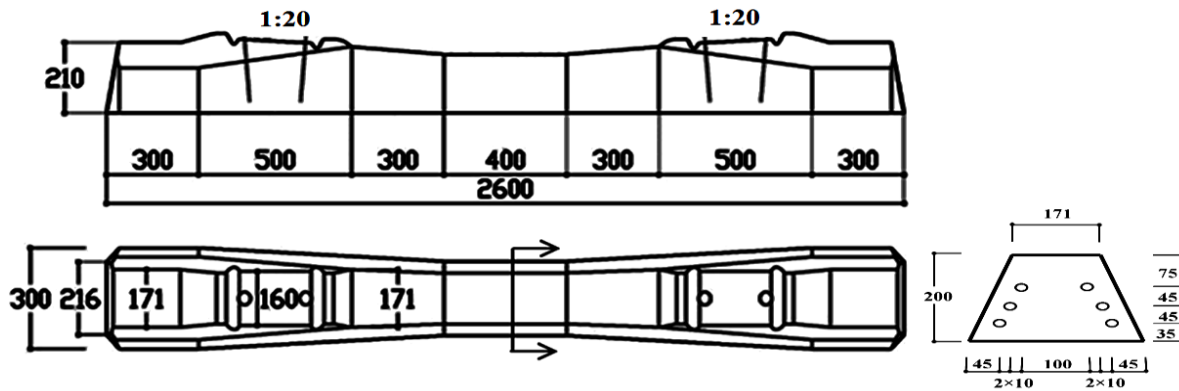
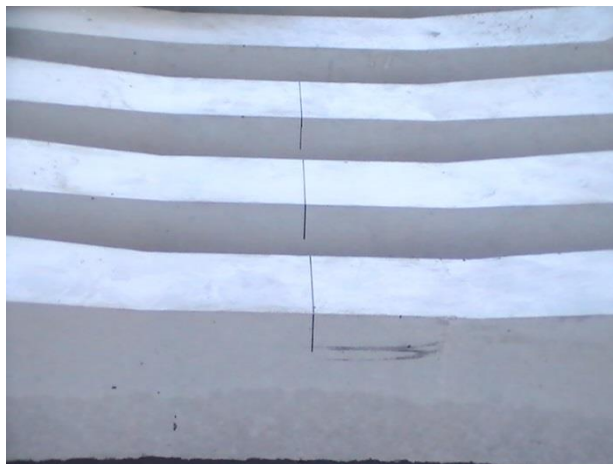

Figure 1. Geometrical sizes of pre-stressed concrete sleepers B70 (mm) [Rezaie, Shiri and Farnam, 2012].



a. The center of the sleepers is painted before cutting. b. The center of the sleepers is cut.
Figure 2. The center of the sleeper specimens.

Table 2. Mechanical characteristics of steel rebar.

Density	ν	f_y	E_t	E_s
7850 kg/m ³	0.3	1400 MPa	2000 MPa	200000 MPa



Figure 3. Three-pointed bending test with the load cell and the displacement gage.

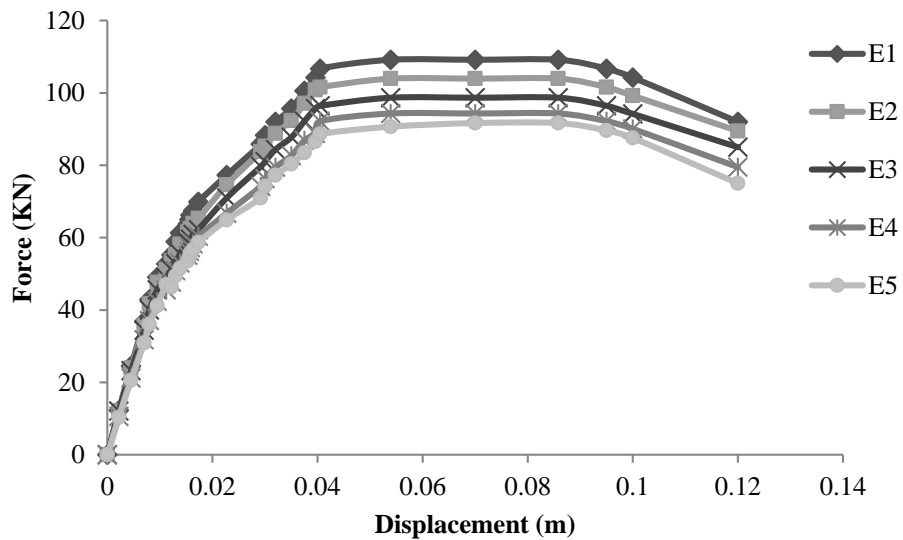

Figure 4. Load-displacement diagram of experimental samples.

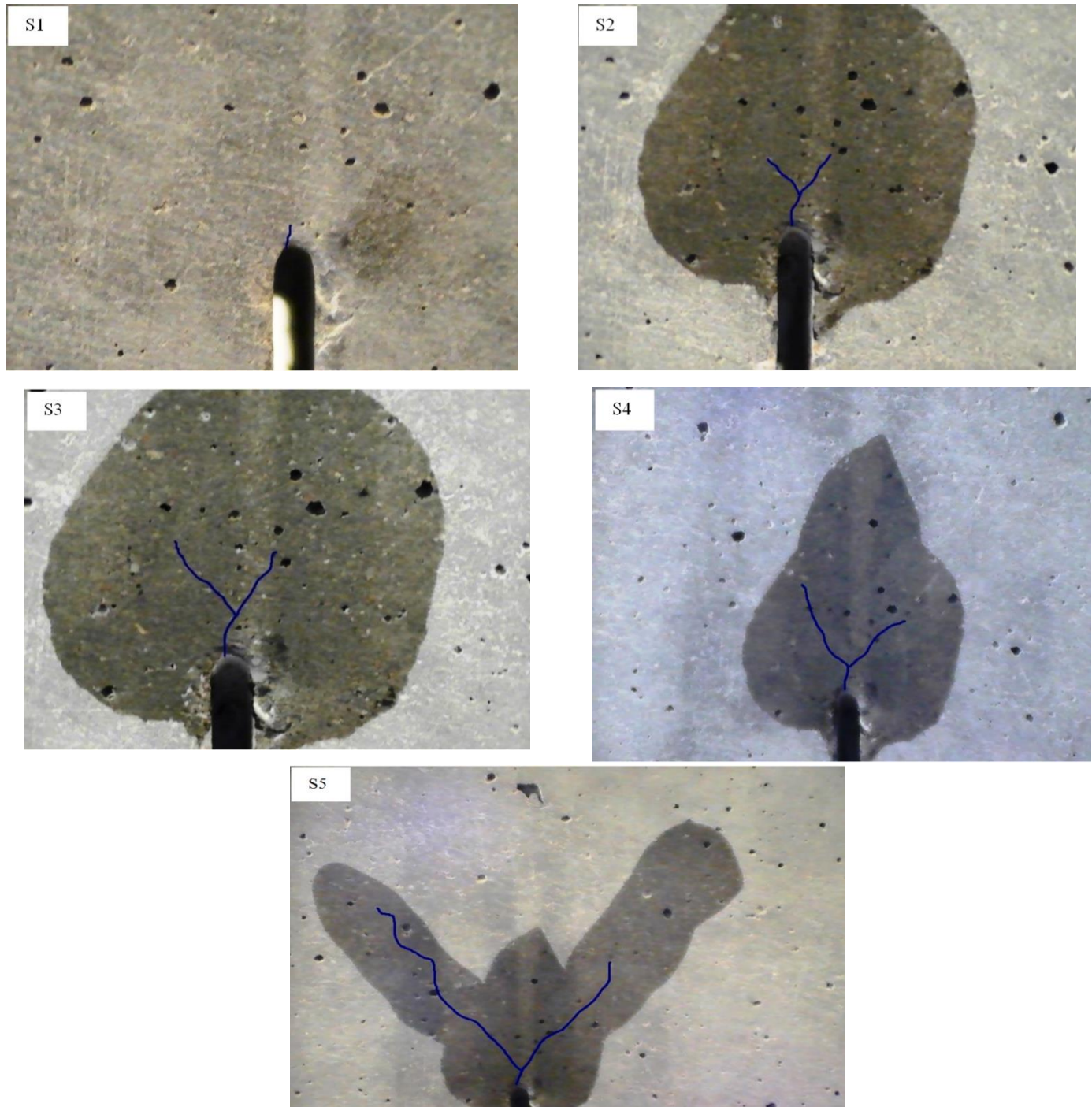

Figure 5. Sleeper's center sample with damage growth.

2.2 Test Content

In this paper, experimental method is done using a jack with a digital load cell (ton unit) and displacement gage as shown in Figure 3.

Sleepers are loaded in three point bending test by static load. A load was increasing at a rate 20 kN/min based on the recommendation of "Australian Standard, AS 1085-14". A more detailed discussion on the test settings

and the characteristics of concrete and rebar could be found in Part A of the paper. The main collected data includes load-displacement diagram of the sleeper's pre-stressed concrete, damage growth, and critical toughness (K_{Ic}). In order to analyze the whole load development process and to test load initiation for each specimen, image processing is used.

3. Results

3.1 Load-Displacement Diagram

In this section, experimental load-displacement diagrams are measured. In fact by testing full scale samples of pre-stressed concrete sleepers, the results of the load-displacement diagram are determined on the initiation of the crack in the samples, as shown in Figure 3. The load cell is placed on the top of the jack at the mid-span and the displacement gage is located at the bottom of the sleeper center.

In these tests, 25 sleeper samples with initial cracks are analyzed using the 30-step method. Load and displacement data are recorded. The average load-displacement diagram resulting from 5 experimental samples is as shown in Figure 4 for 5 initial cracks. E1, E2, E3, E4, and E5 correspond to 5, 15, 25, 35, and 45 mm initial cracks, respectively.

As shown in Figure 5, central area of the sleeper in which the damage has occurred is shown in 5 steps for experimental sample. The damage grows larger step by step until the final damage. In the first step (s1), the initial damage appears at the central of the sleeper exactly on the initial crack. It grows more outwards after the expansion of the cracks in an orthogonal direction. At the second step (s2), the crack bifurcates and starts to grow horizontally in a symmetric

manner. By the third, fourth, and fifth steps (s3, s4, s5), the crack continues to grow in vertical direction and causes damage as it passes through the elements.

In Figure 6, at the sixth and seventh steps (s6, s7), new cracks appear from the left and right sides, respectively and they begin to approach the center. The crack from the sides is growing vertically around the central crack which has reached the final damage level and is heading to damage. So, it expands in a variety of directions that lead to the final damage level. At the final step (s8), the sleeper has reached the final damage and cannot bear more loads.

3.3 Stress Intensity of Critical Toughness K_{Ic}

3.3.1 Analytical Formula for Fracture NLFM Parameters

During the manufacturing and preparation of the pre-stressed concrete sleeper (such as pulling and releasing the bars, curing of concrete, etc.), the conditions are provided for the creation of initial cracks in the sleeper. Furthermore, the compressive stress in the traction zone of pre-stressed concrete, which is produced by the steel bars, postpones the crack propagation speed and changes the structural properties that cause an increase in the damage capacity of the structure. In fracture mechanics, the stress intensity factor (K) is used to predict the stress intensity (stress state) close to the tip of a crack that is produced by a distant load or residual stresses [Anderson, 2005]. The first mode of critical stress intensity factor (K_{Ic}) is the most common mode used in fracture mechanics design. If it is assumed that at some critical combination of stress and strain, the material fails locally, then the fracture must happen at critical stress intensity K_{Ic} .

Experimental Analysis of Fracture and Damage Mechanics of Pre-Stressed Concrete ...

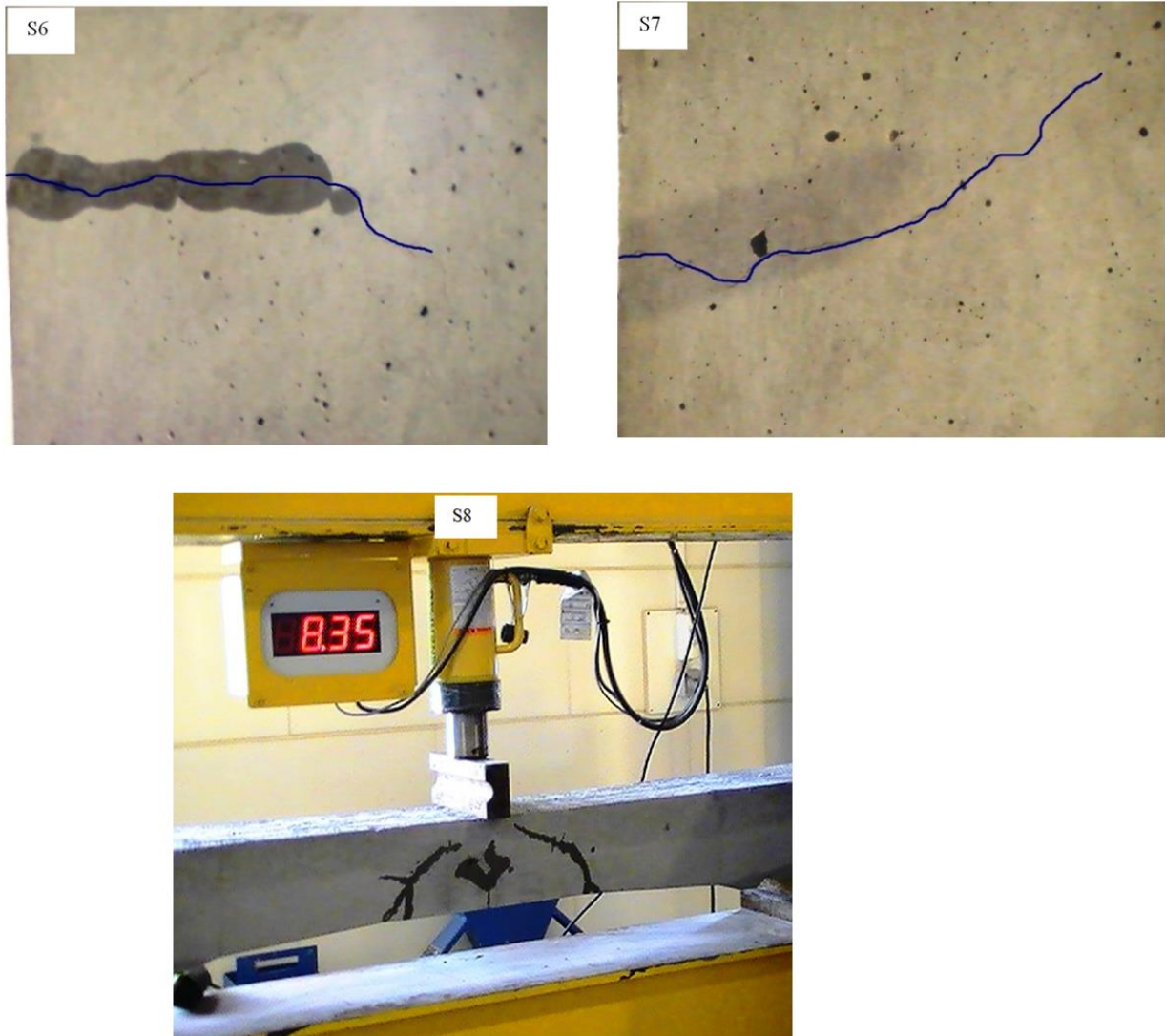

Figure 6. Sleeper with damage growth.

Therefore, K_{Ic} is an alternate measure for fracture toughness [Anderson, 2005]. At the same time, by increasing the load, the intensity ratio of stress in the crack's tip increases gradually according to tension concentration. When the amount of initial toughness (K_{IC}^{ini}) of the pre-stressed concrete becomes the same to the intensity ratio of the stress produced by the bars and the load on the crack tip (K_{IS}, K_{IP}), then the crack starts

to develop in the sample. Also, the special effects of the damaged fragments of the crack tip should be considered, that is, generally equal to the adherence effect or the virtual crack in concrete samples section. As a result, the created stress intensity ratio caused by adherence K_I^C should be added to the earlier parameters (K_{IS}, K_{IP}). While the stress intensity made by the bars, loading, and adherence at the tip of the cracks is equal

to the crack unstable toughness K_{IC}^{un} , the crack instability expansion initiates and by gradually disabling the concrete section capacity, the load would be entirely tolerated by the reinforcements. Thus, when the damage in the reinforced concrete begins to grow, the exact stress intensity ratio can be obtained using Equations 1 and 2 by SL 352-2006 "Test code for hydraulic concrete of china"(Equations 1 and 2). Here, for the stress intensity ratio, due to the loading on the cracks when being unstable, it is assumed that the bars are completely embedded in concrete and no slipping happens between them. The stress intensity factor created by load can be obtained through Fracture Test of Hydraulic Concrete in NLFM theory (Equations 3-6). Where m is a measure for support conditions of the samples (according to the conversion of s/l), s is the length among the supports, and l is the length of the whole sample. When the cracks are exposed to the surface, the amount of the stress intensity due to the bars can be calculated using the following equations. (Equations 7 and 8) Where A_0 is the area of bars cross section, c is the distance between the rebar in the center and the edge of the sample section, $\eta = \frac{c}{a_0}$, $\xi = \frac{a_0}{h}$, and F_s^{ini} are the responses of pre-stressing force when the cracks appear in concrete. Furthermore, by assuming bars being completely embedded in concrete, the crack unstable toughness due to the rebar on the crack's tip would be calculated using Equations 9 and 10. in concrete are unstable and a_c is the critical crack length; also for the plastic zone, it would have Where $\eta_1 = \frac{c}{a_c}$, $\xi_1 = \frac{a_c}{h}$, and F_s^{un} are the responses to the pre-stressing force when the cracks (Equations 11 and 12):

$$K_I^{ini} = K_{IP}^{ini} - K_{IS}^{ini} \quad (1)$$

$$K_I^{un} = K_{IP}^{un} - K_{IS}^{un} \quad (2)$$

$$K_{IP}^{ini} = \frac{1.5(p^{ini} + \frac{mg}{2} \times 10^{-2}) \times 10^{-3} s a_0^{1/2}}{t h^2} f(\alpha) \quad (3)$$

$$f(\alpha) = \frac{1.99 - \alpha(1 - \alpha)(2.15 - 3.93\alpha + 2.7\alpha^2)}{(1 + 2\alpha)(1 - \alpha)^{3/2}}$$

$$\alpha = \frac{a_0}{h} \quad (4)$$

$$K_{IP}^{un} = \frac{1.5(p^{un} + \frac{mg}{2} \times 10^{-2}) \times 10^{-3} s a_c^{1/2}}{t h^2} f(\alpha) \quad (5)$$

$$f(\alpha) = \frac{1.99 - \alpha(1 - \alpha)(2.15 - 3.93\alpha + 2.7\alpha^2)}{(1 + 2\alpha)(1 - \alpha)^{3/2}}$$

$$\alpha = \frac{a_c}{h} \quad (6)$$

$$K_{IS}^{ini} = \frac{2F_s^{ini}}{b\sqrt{\pi a_0}} F\left(\frac{c}{a_0}, \frac{a_0}{h}\right), F_s^{ini} = E_s \varepsilon_s^{ini} A_0 \quad (7)$$

$$F(\eta, \xi) = \left\{ \begin{array}{l} \frac{3.52(1-\eta)}{(1-\xi)^{3/2}} - \frac{4.35-5.28\eta}{(1-\xi)^{1/2}} + \\ \left[\frac{1.30-0.30\eta^{3/2}}{(1-\eta^2)^{1/2}} + 0.83-1.76\eta \right] \times \\ [1-(1-\eta)\xi] \end{array} \right\} \quad (8)$$

$$K_{IS}^{un} = -\frac{2F_s^{un}}{b\sqrt{\pi a_c}} F_1\left(\frac{c}{a_c}, \frac{a_c}{h}\right) \quad (9)$$

$$F_1(\eta_1, \xi_1) = \left\{ \begin{array}{l} \frac{3.52(1-\eta_1)}{(1-\xi_1)^{3/2}} - \frac{4.35-5.28\eta_1}{(1-\xi_1)^{1/2}} + \\ \left[\frac{1.30-0.30\eta_1^{3/2}}{(1-\eta_1^2)^{1/2}} + 0.83-1.76\eta_1 \right] \times \\ [1-(1-\eta_1)\xi_1] \end{array} \right\} \quad (10)$$

$$F_s^{un} = \sigma_s^{un} A_0 = f_y A_0 \quad (11)$$

$$F_s^{un} = \sigma_s^{un} A_0 = E_s \varepsilon_s^{un} A_0 \quad (12)$$

3.3.2 Stress Intensity Ratio Determination

To determine the stress intensity ratio, 5 samples of B70 pre-stressed concrete sleeper are used. All the samples have the same characteristics. The only difference between them is the length of the initial crack. The length of initial cracks in the samples ranges from 5 to 45 mm with the growth step of 10 mm. According to the equations in the previous section, the initial toughness K_I^{ini} and unstable toughness K_I^{un} for the crack-to-depth ratio is as shown in Figures 7 and 8.

As shown in Figures 7 and 8, the initial and unstable toughness in B70 pre-stressed concrete sleeper, is calculated in 5 different amounts. It can be seen in the figures that the toughness increases linearly as crack-to-depth ratio increase in experimental samples versus LEFM theory.

4. Discussion and Conclusion

Calculating the fractural mechanics parameters in materials and elements is considered as an important discussion in modern engineering design, because of the belief that crack growth and resistance reduction of the structure and the subsequent effects on the structural behavior are the cause of exiting from service conditions. Therefore, in this research, based on the available foundations in fractural mechanics, the main fractural mechanics parameters of pre-stressed concrete sleeper B70 which is widely used in Iran's railway lines are determined. This information could be used to design fractural mechanics of this part. Sleepers are among the main elements in

railway lines. They behave like beams and their mechanism is that of a beam. In this study, full scale specimens of pre-stressed concrete sleeper B70 are created according to Iran's specifications. The first plastic damage schematic for determining the damage of samples is measured from load-displacement output calculated. Finally, considering the load effects, reinforcement, and adhesion in stress intensity parameter, the initial and unstable toughness are measured and the load-displacement diagrams of 5 sleepers are depicted. Crack growth and toughness are also important parameters in the fractural mechanics behavior of samples. Crack growth and damage are displayed in this study in one of the 25 experimental samples that has 45 mm initiation crack. Sleepers begin with an initial crack like in flexural damage and then continue with bifurcation of the crack. The influence of shear damage in sleeper's crack growing leads it to the ultimate damage. Also, at the final failure step, the damage in other parts of the sample is visible, showing the complication of deterioration. The final chapter of this study can use the existing analysis in this research to determine the toughness parameter of pre-stressed concrete and calculate the effective parameters in determining the stress intensity. The unstable and initial toughness are used to design the fractural mechanic of sleepers. In fact, by computing the toughness parameter of B70 pre-stressed concrete sleeper in 5 different crack-to-depth ratios, one can accurately calculate the toughness of B70 pre-stressed concrete sleeper and use it for fractural mechanic designing purposes. Therefore, if K_{IC}^{ini} is equal to the amount of critical stress intensity, then the initial crack starts to propagate and at last it causes the full damage of sample before its service lifetime is over. Results in Figures 7 and 8 are related to initial toughness, K_{IC}^{ini} , and unstable

toughness, K_{IC}^{un} , respectively displaying that the toughness increases with crack-to-depth

ratio linearly in average result (AVE) of 5 samples versus LEFM theory.

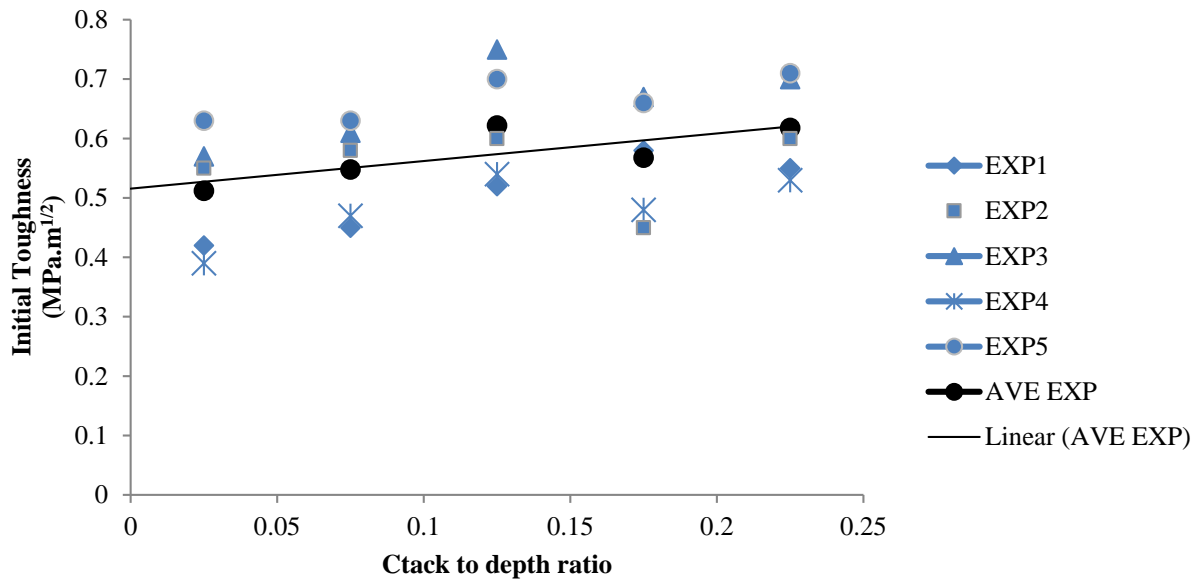

Figure 7. The experimental results of changes of initial toughness versus the crack-to-depth ratio.

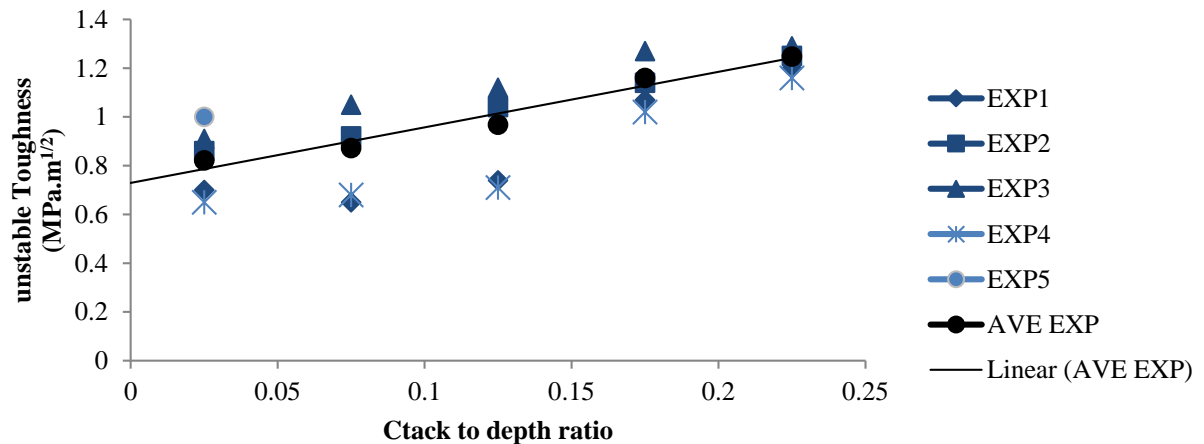

Figure 8. The experimental results of changes of unstable toughness versus the crack-to-depth ratio.

5. Acknowledgements

The authors are grateful to “Designing and Engineering Group of IRI Railway” and the pre-stressed concrete sleeper B70 production

firm: “Brace Concrete Industries Company” for financial and equipment support.

6. References

-AREMA (2010) “Evaluation tests for tie systems”, Chapter 30, Part 4, “concrete ties”,

Experimental Analysis of Fracture and Damage Mechanics of Pre-Stressed Concrete ...

American Railway Engineering and Maintenance of Way Association.

-AS-1085.14 (2012) Railway Track Material Part 14 : “Pre-stressed concrete sleepers”, Standard Australia, 2012.

-Anderson, T. L. (2005) “Fracture mechanics: Fundamentals and application”, 3rd. Ed., CRC Press.

-Azad, A., Mirza, M. and Chan, P. (2007) “Fracture energy of weakly reinforced concrete beams”, Fatigue. and. Fract. of. Eng. Mater. and. Struct. Vol. 12, pp.9–18.

-Eftekhari, M., Ardakani, S. H. and Mohammadi, S. (2014) “An XFEM multiscale approach for fracture analysis of carbon nanotube reinforced concrete”, Theoretical and Applied. Fract. Mech. Vol. 72, pp.64-75

-Ferro, G., Carpinteri, A. and Ventura, G. (2007) “Minimum reinforcement in concrete structures and material structural instability”, Int. J. of. Fract., Vol. 146, pp.213–231.

-González-Niciezaa, C., Álvarez-Fernández, M. I., Menéndez-Díazb, A., Álvarez-Vigilc, A. E. and Ariznavarreta-Fernández, F. (2008) “Failure analysis of concrete sleepers in heavy haul railway tracks”, Eng. Fail. Anal. Vol. 15, pp.90–117

-Kaewunruen, S. and Remennikov, A. M. (2007) “Experimental and numerical studies of railway pre-stressed concrete sleepers under static and impact loads”, Asian Institute of Technology, Civil Computing, Vol. 3, pp.25-28.

-Kaewunruen, S. and Remennikov, A. M. (2006) “Nonlinear finite element modeling of railway pre-stressed concrete sleeper”, Proceedings of the 10th East Asia-Pacific Conference on Structural Engineering and Construction (EASEC-10), Bangkok, Thailand, August. Vol. 4, pp.323-328

-Kaplan, M. E. (1961) “Crack propagation and the fracture concrete”, ACI. J. Vol. 58, pp.596-610.

-Karihaloo, B. L. and Nallathambi, P. (1989) “Fracture toughness of plain concrete from tree bend specimens”, Mater. and. Struct. Vol. 22, pp.185-193

-Malvar, L. J. and Warren, G. E. (1987) “Fracture energy for three point bend tests on single edge notched beams: Proposed evaluation”, Mater. and. Struc. Vol. 20, pp.440-447.

-Remennikov, A. M. and Kaewunruen, S. (2014) “Experimental load rating of aged railway concrete sleepers”, Eng. Struct. Vol. 76, pp.147–162.

-Remennikov, A. M. and Kaewunruen, S. (2007) “Resistance of railway concrete sleepers to impact loading”, Proceedings of the 7th. International Conference on Shock and Impact Loads on Structures, Beijing, China. pp.489-496.

-Rezaei, F., Shiri, M. R. and Farnam, S. M. (2012) “Experimental and numerical studies of longitudinal crack control for pre-stressed concrete sleepers”, Eng. Fail. Anal. Vol. 26, pp.21–30.

-Ruiz, G., Elices, M. and Planas, J. (1998) “Experimental study of fracture of lightly reinforced concrete beams”, Mater. and. Struct. Vol. 31, pp.683–691.

-Santosh, M. and Ghosh, M. A. (2015) “Multi-scale identification of concrete material parameters”, Theoretical. and. Applied. Fract. Mech. Vol. 75, pp.8-15.

Shah, S. P. and Mac-Garry, F. J. (1971) “Griffith fracture criterion and concrete”, J. of. Eng. Mech. Division. Vol. 97, pp.1663-1676.

-Shaowei, H. U., Jun, L. U. and Xiaoqing, Z. (2011) “Study on characteristics of acoustic emission property in the normal concrete fracture test”, Adv. Mater. Res. Vol. 189-193, pp.1117–1121.

SL (2006) 352-2006, Test code for hydraulic concrete of china. “Water Conservancy and Electric Power Press”, 2006.

-Thai, D. K. and Kim, S. E. (2014) "Analysis of reinforced concrete walls under impact loading using the finite element approach", Eng. Fail. Anal. Vol. 45, pp.252-277.

-Vesely, V., Konecny, P. and Lehner, P. (2015) "Influence of crack propagation on electrical resistivity and ultrasonic characteristics of normal concrete assessed by sequential TPB

fracture test", Theoretical. and. Applied. Fract. Mech. Vol. 80, pp.2-13.

-Zhao, J., Chan, A. H. C. and Burrow, M. P. N. (2007) "Reliability analysis and maintenance decision for railway sleepers using track condition information", J. Oper. Res. Soc. Vol. 58, pp.1047-1055.